

Contemporary living

Groove #1



DOMINGO[®]

Contemporary living

Groove

“Non può esserci nessuna nuova nota. Se guardi la tastiera, tutte le note sono già lì. Ma se dai a una nota un particolare significato, quella nota avrà un suono diverso”

“The piano ain't got no wrong notes. It can't be any new notes. When you look at the keyboard, all the notes are there already, but if you mean a note enough, it will sound different”

Thelonious Monk

IDOMINGO®



Groove è una selezione di divani, poltrone e tavolini contemporanei minimalisti e sofisticati. Forme e materiali si accordano in una ritmica delicata, frutto di una ricerca attenta e di un'esecuzione accurata, ove la bellezza si genera attraverso segni di stile e dettagli accattivanti.

Groove is a selection of refined minimalist sofas, armchairs and coffee tables. Shapes and materials get in tune with a delicate rhythm that is the outcome of a painstaking research and a meticulous execution where beauty flows through stylish and captivating details.

Divani
Sofas

Barlow 10

Cox 32

Crosby 48

Foy 68

Tilton 88

Poltrone e pouf
Armchairs and poufs

Dinah 106

Parker 107

Duke 108

Dizzy 109

Billie 110

Frank 111

Joe 112

Tavolini
Small tables

Tabbal 116

Taborn 118

Priamo 120

Tablette 122

Warhol 124

Ceo 126

Febe 128

Rea 130

Teti 132

Zaikin 134

Divani
Sofas

Barlow 10



Cox 32



Crosby 48



Foy 68



Tilton 88



Poltrone e pouf
Armchairs and poufs

Dinah 106



Parker 107



Duke 108



Dizzy 109



Billie 110



Frank 111



Joe 112



Tavolini
Small tables

Tabbal 116



Taborn 118



Priamo 120



Tablette 122



Warhol 124



Ceo 126



Febe 128



Rea 130



Teti 132



Zaikin 134



Divani Sofas

Il divano è un oggetto rassicurante,
un territorio accogliente e confortante,
che aspetta solo di essere abitato.

Sofas are reassuring
objects, a welcoming
and comforting territory
waiting to be inhabited.

Barlow

Barlow è la forza della leggerezza, la raffinatezza dell'essenziale e la delicatezza di un dettaglio quasi impercettibile. Una collezione componibile le cui geometrie rigorose, interrotte da morbidezze inaspettate e arricchite da esercizi di sartorialità, generano vibrazioni profonde nei puristi delle forme minimaliste.

Barlow is the strength of lightness, the elegance of essence and the subtlety of an almost imperceptible detail. A modular collection whose rigorous geometries, interrupted by unexpected softness and enriched by tailoring expertise, generate deep vibrations in purists who favor a minimalist style.



Divani/Sofas
Barlow
Composizione 1
Composizione 1

Tavolini/
Small tables
Ceo

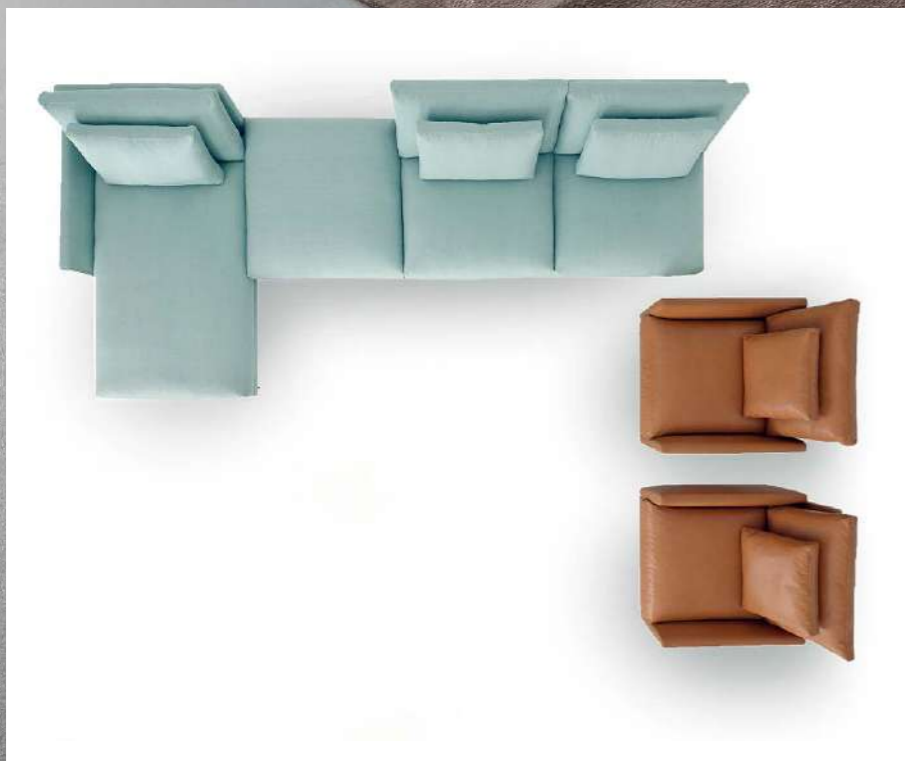



Il dettaglio del bracciolo con inserto in pelle è una scelta di stile che si inserisce con naturalezza nelle linee essenziali di Barlow, un valore aggiunto alle sue geometrie rigorose.

The leather insert in the armrest is a stylish detail that fits naturally into Barlow's essential lines, an added value to its rigorous geometries.









Barlow
Composizione 3
Composition 3

Poltrona/
Armchair
Parker

Tavolini/
Small tables
Rea
Ceo





Barlow
Composizione 3
Composition 3

Poltrona/
Armchair
Parker

Tavolini/
Small tables
Rea
Ceo





Divani/Sofas
Barlow
Divano tre posti
Three seater sofa



Divani/Sofas
Barlow
Composizione 3
Composition 3

Tavolini/
Small tables
Rea
Ceo

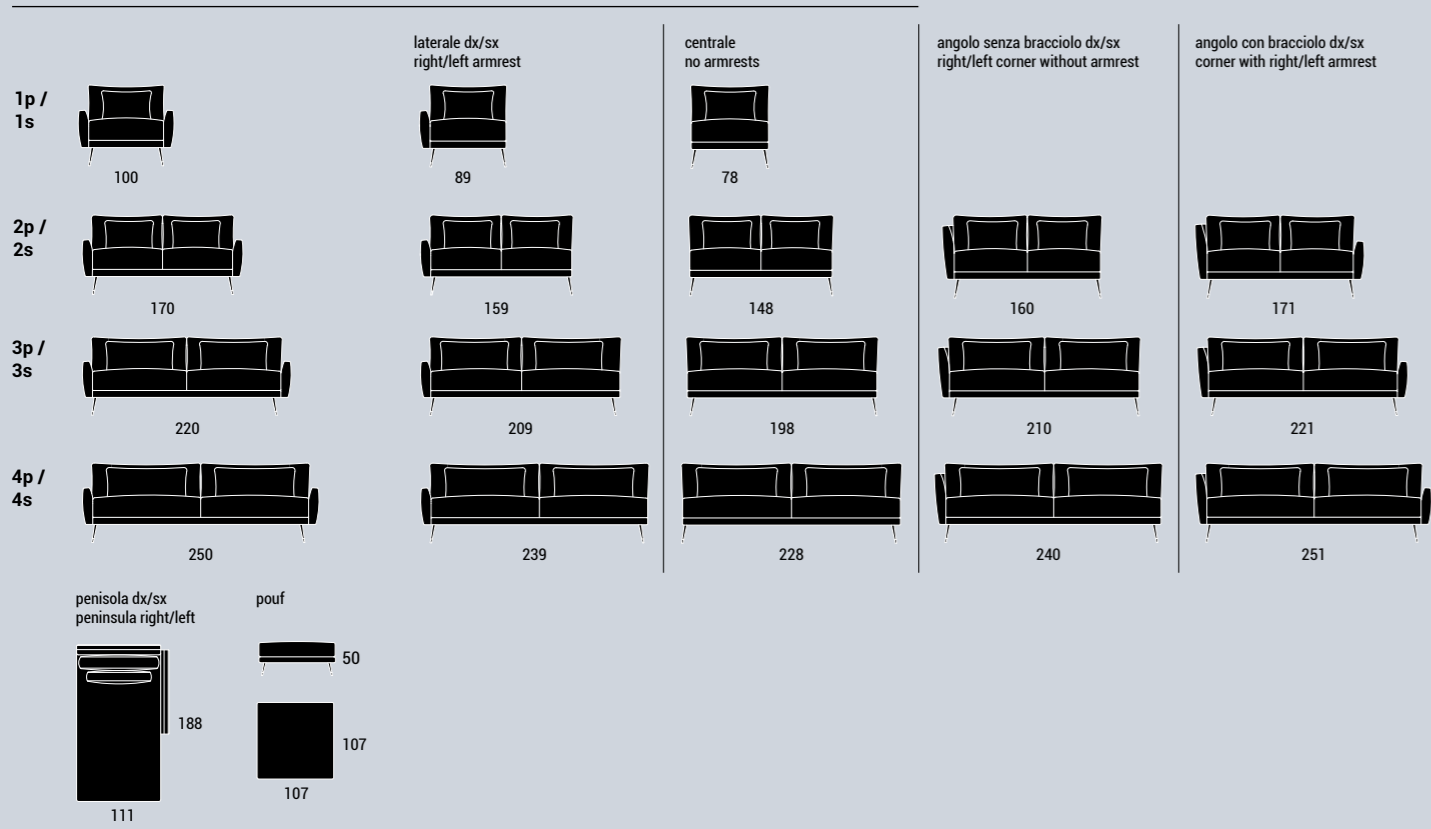

Composizioni suggerite
Suggested configurations

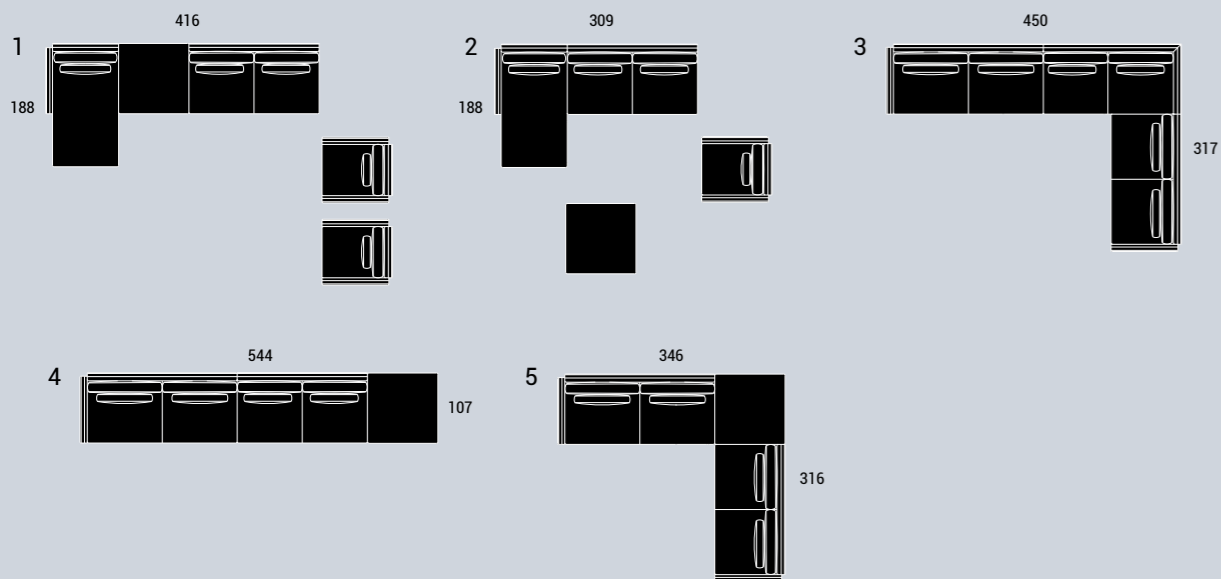

- 1 penisola sx + pouf + 3P centrale + 2x 1P
peninsula left + pouf + 3S no armrests + 2x 1S
- 2 penisola sx + 3P centrale + 1P + pouf
peninsula left + 3S no armrests + 1S + pouf
- 3 3P sx + 2P angolo senza bracciolo dx + 3P dx
3S left + 2S right corner without armrest + 3S right
- 4 4P sx + 3P centrale + pouf
4S left + 3S no armrests + pouf
- 5 4P sx + pouf + 3P dx
4S left + pouf + 3S right

Struttura in legno di abete e multistrato di pioppo in vari spessori, cl. E1 a bassa emissione di formaldeide. Imbottitura in poliuretano espanso indeformabile in densità da 30 a 40 kg/m³ e ovatta in poliestere. Cinghie elastiche da 80 mm. Piedi in metallo e acciaio inox. Resine e collanti utilizzati sono privi di sostanze ozonolesive, CFC e solventi clorurati. Tutti i materiali impiegati rispettano la normativa EU 91/156 per lo smaltimento dei rifiuti. Prodotto lavorato interamente a mano in Italia.

Fir wood and poplar plywood frame (thickness varies), cl. E1 low formaldehyde emission. Crushproof polyurethane foam padding (density varies from 30 to 40 kg/m³) and polyester wadding. 80-mm elastic straps. Metal and inox steel legs. The resins and adhesives employed are free of ozone-depleting substances, CFCs and chlorinated solvents. All materials comply with EU regulation 91/156 for waste disposal. Manufactured entirely by hand in Italy.

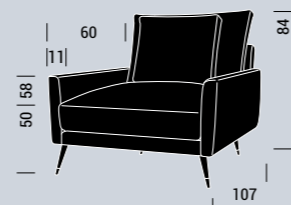

Barlow



1 penisola sx + pouf + 3P centrale + 2x 1P
peninsula left + pouf + 3S no armrests + 2x 1S



3 3P sx + 2P angolo senza bracciolo dx + 3P dx
3S left + 2S corner right without armrest + 3S right

P 115
Piedi Feet



50L
Nero opaco liscio
Smooth matt black
Ral 9005

Tessuti Fabrics

Lino Linen



G077 col.09

Pelle Leather



Lux col.2434

Velluto Velvet



8336 col.53

Bracciolo
Armrest

DI SERIE / STANDARD



Cucitura semplice
Top-Stitched Seam

OPTIONAL



Con inserto in pelle
With leather insert

Cuscini seduta e schienale
Seat and backrest cushions

DI SERIE / STANDARD



Liscio tradizionale
Cushion

OPTIONAL



Trapuntato
Square quilted

Dettaglio piedi
Feet detail



P 116
H 18
Piede in metallo verniciato
nero con puntale in oro
Black metal conical feet
with golden cap



P 115
H 18
Piede in acciaio inox lucido
Polished inox steel foot

Finiture piede P 115
Foot P 115 finishings



01
Bianco opaco goffrato
Rough matt white
Ral 9010



75L
Delfino opaco liscio
Smooth matt dolphin
Ral 7038



11L
Sand opaco liscio
Smooth matt sand
Ral 7038



127L
Arabia opaco liscio
Smooth matt arabia
Ral 7038



92
Bronzo antico opaco
goffrato Rough matt
old bronze Ral 8017



32L
Ardesia opaco liscio
Smooth matt slate
Ral 7011



50L
Nero opaco liscio
Smooth matt black
Ral 9005

Cox

Cox si ispira alla tradizione delle sedute imbottite sfruttando in modo originale i diversi elementi costruttivi. La scelta di una nota di stile sul bracciolo e un'inflexione sullo schienale danno vita ad un divano al tempo stesso rassicurante ed ammiccante, la cui forza, oltre al piacere visivo è l'attrazione per l'esperienza di comfort che trasmette a chi lo osserva.

The inspiration for Cox was drawn directly from the tradition of upholstered furniture, but structural elements are slightly redefined. A sinuous detail in the armrest and the rigorous yet cushy pragmatism of the backrest connote a sofa that is both reassuring and fancy. Its strength, aside from aesthetic pleasure, is the irresistible idea of comfort it conveys.

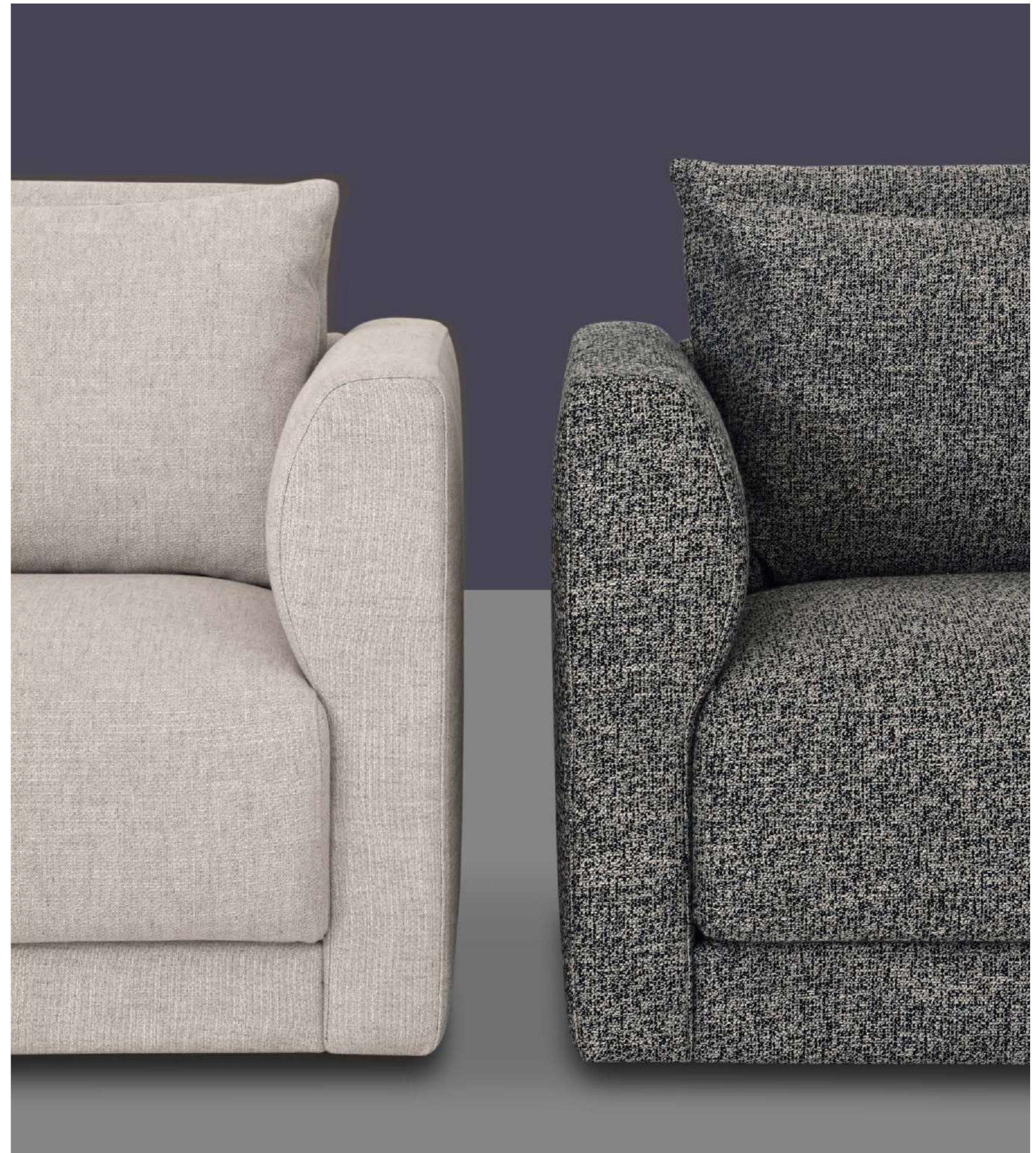

Divani/Sofas
Cox
Composizione 1
Composition 1

Tavolini/
Small tables
Taborn
Warhol





Divano/Sofa
Cox
 Divano tre posti
 Three seater sofa



Divani/Sofas
Cox
 Composizione 1
 Composition 1

Poltrona/
 Armchair
Duke

Tavolini/
 Small tables
Taborn
Warhol

Divani/Sofas
Cox
Composizione 1
Composition 1

Poltrona/
Armchair
Duke

Tavolini/
Small tables
Taborn
Warhol





Divano/Sofa
Cox
Poltrona
Armchair



Divani/Sofas
Cox
Composizione 1
Composizione 1

Poltrona/
Armchair
Duke

Tavolini/
Small tables
Taborn
Warhol



Divano/Sofa
Cox
Pouf

Divani/Sofas
Cox
Composizione 2
Composition 2



Divani/Sofas
Cox
Composizione 5
Composition 5



Divani/Sofas
Cox
Composizione 3
Composition 3



Divani/Sofas
Cox
Composizione 4
Composition 4

Tavolini/
Small tables
Warhol
Ceo



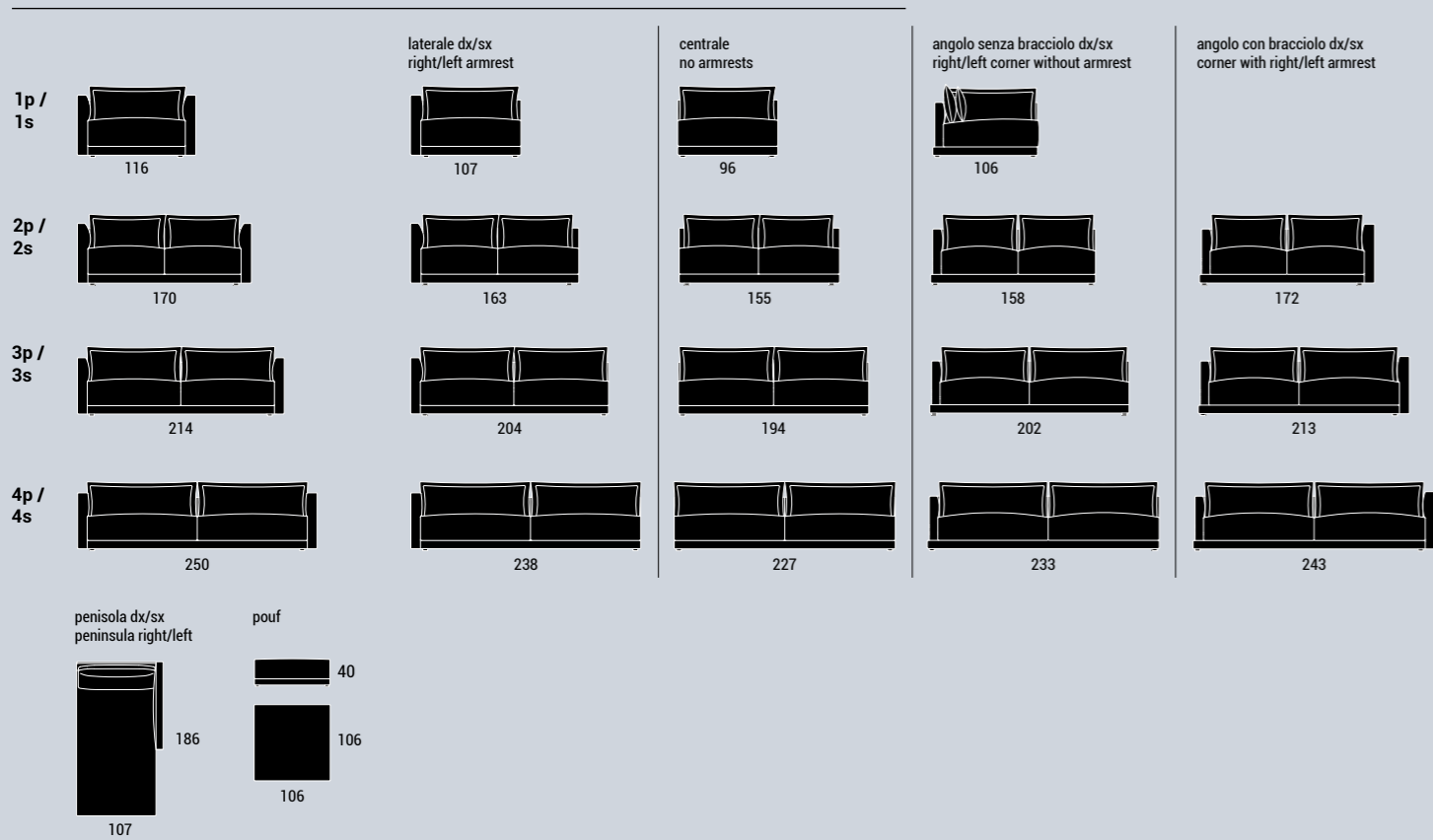

Composizioni suggerite
Suggested configurations

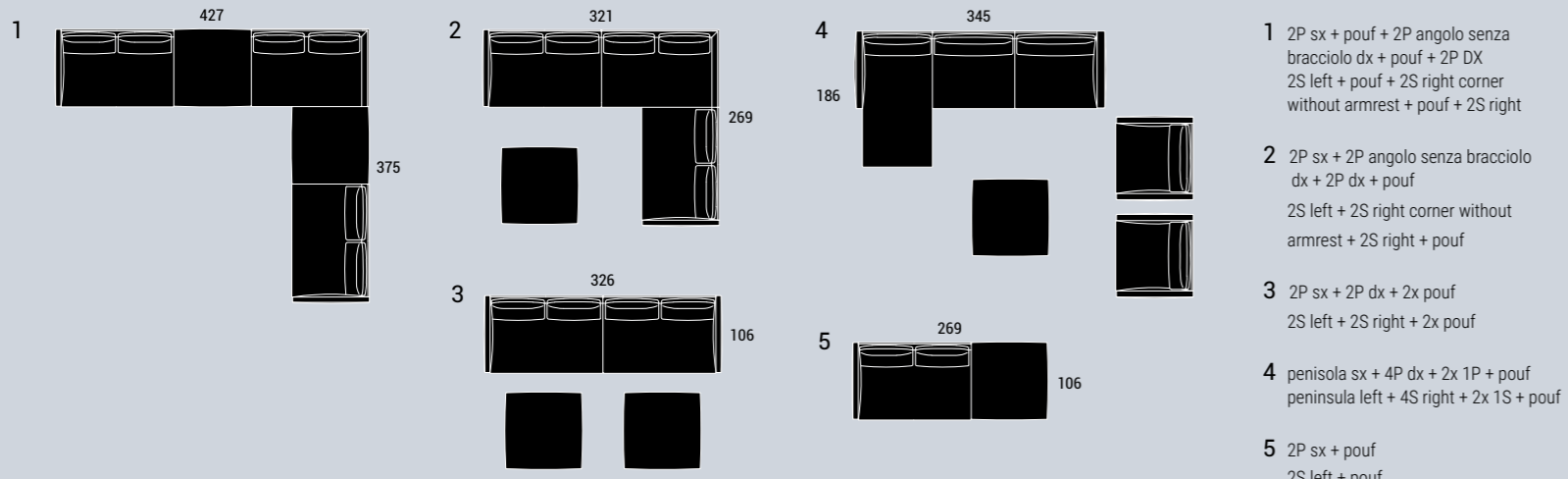

Struttura in legno di abete e multistrato di pioppo in vari spessori, cl. E1 a bassa emissione di formaldeide. Imbottitura in poliuretano espanso indeformabile in densità differenziate da 30 a 40 kg/m³, ovatta in poliester e piuma sintetica ecocompatibile. Piedi in legno. Resine e collanti utilizzati sono privi di sostanze ozonolesive, CFC e solventi clorurati. Tutti i materiali impiegati rispettano la normativa EU 91/156 per lo smaltimento dei rifiuti. Prodotto lavorato interamente a mano in Italia.

Fir wood and poplar plywood frame (thickness varies), cl. E1 low formaldehyde emission. Non-deformable polyurethane foam padding (density varies from 30 to 40 kg/m³), polyester wadding and eco-friendly synthetic down. Wooden feet. The resins and adhesives employed are free of ozone-depleting substances, CFCs and chlorinated solvents. All materials used comply with EU 91/156 regulations for waste disposal. Manufactured entirely by hand in Italy.

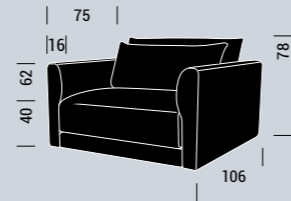

Cox



2P sx + pouf + 2P angolo senza bracciolo dx + pouf + 2P DX
2S left + pouf + 2S right corner without armrest + pouf + 2S right



2P sx + 2P angolo senza bracciolo dx + 2P dx + pouf
2S left + 2S right corner without armrest + 2S right + pouf



2P sx + 2P dx + 2x pouf
2S left + 2S right + 2x pouf



2P sx + pouf
2S left + pouf

Tessuti Fabrics



L1649 col.04



penisola sx + 4P dx + 2x 1P + pouf
peninsula left + 4S right + 2x 1S + pouf

Tessuti Fabrics

Ciniglia Chenille



M036 col.20

Jaquard

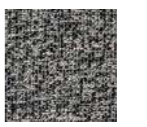

M039 col.01

Velluto Velvet

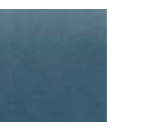

8336 col.55

Dettaglio piede
Foot detail



P 59
H 2
Piede in legno tinto nero
Black stained wooden foot

Crosby

L'improvvisazione può essere una necessità o una virtù, in alcune situazioni è la formula migliore per godere appieno degli spazi e godere la socialità. Crosby è la soluzione senza regole, il divano ideale perché mai definitivo. Pochi elementi costruttivi per dare libera espressione agli istinti creativi e funzionali, restando focalizzati sulle morbidezze e sul comfort.

Improvisation may spring out of need or virtue; when socializing and enjoying the setting is the point, improvisation is the key. Crosby is a rule-free furnishing solution, the ideal sofa as it is never definite. Its essential structural elements leave absolute freedom of expression to creative and functional instincts while remaining focused on softness and comfort.



Divani/Sofas
Crosby
Composizione 1
Composition 1

Tavolini/
Small tables
Priamo









Divani/Sofas
Crosby
Composizione 4
Composition 4

Tavolino/
Small table
Tablette

Pouf
Billie



Divani/Sofas
Crosby
Composizione 5
Composition 5



Divani/Sofas
Crosby
Composizione 6
Composition 6



Moduli/Modules

Sedute/Seats

Pouf 100x100



Pouf 100x50



Pouf 60x50



Strutture/Frames

Schienale singolo
Single backrest



Schienale angolare
Corner backrest



Raccordo sedute
Seat fastening module



Cuscini schienale/Backrest cushions

Large



Small



Accessori/Accessories

Vassoio per pouf 60x50
Tray for pouf 60x50



Componibilità/Modularity

Pouf 100x100



+

Schienale singolo
Single backrest

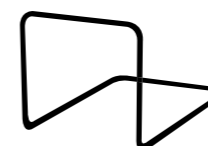

+



+

Cuscino schienale large
Large backrest cushion



Cuscino schienale small
Small backrest cushion



=

Poltrona
Armchair



Pouf 100x100



+

Schienale angolare
Corner backrest

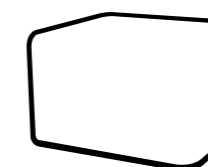

+



+

Cuscino schienale large
Large backrest cushion



Cuscino schienale small
Small backrest cushion



=

Angolo
Corner



Modularità/Modularity

**Sistema di aggancio dello schienale/
Backrest connection**

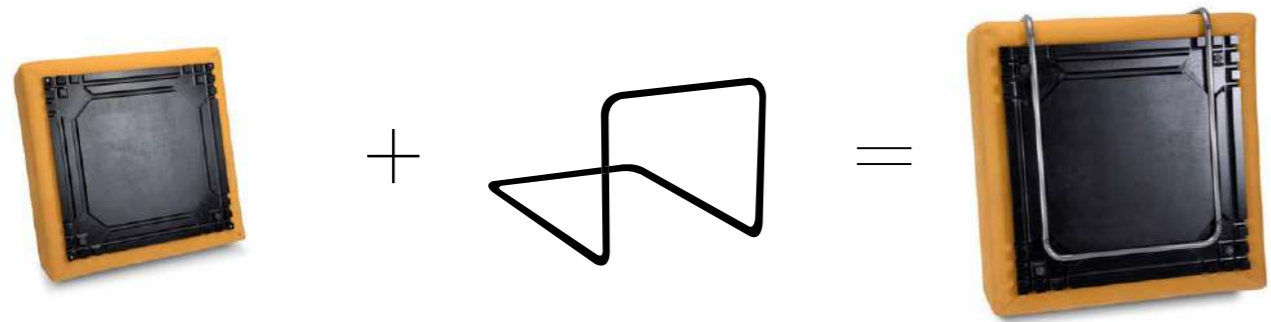

**Posizione dei cuscini schienale/
Backrest cushion setting options**



**In appoggio
Stopped**

**Ad incastro
Inserted**

**Cerniera di fissaggio
Fastening zipper**



**Sistema di raccordo sedute/
Seats modulo fastening**

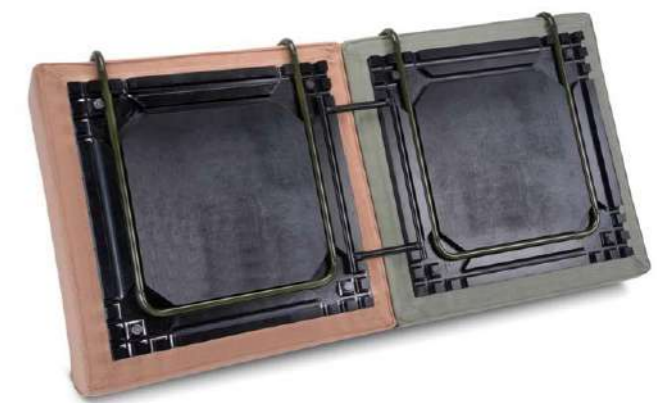
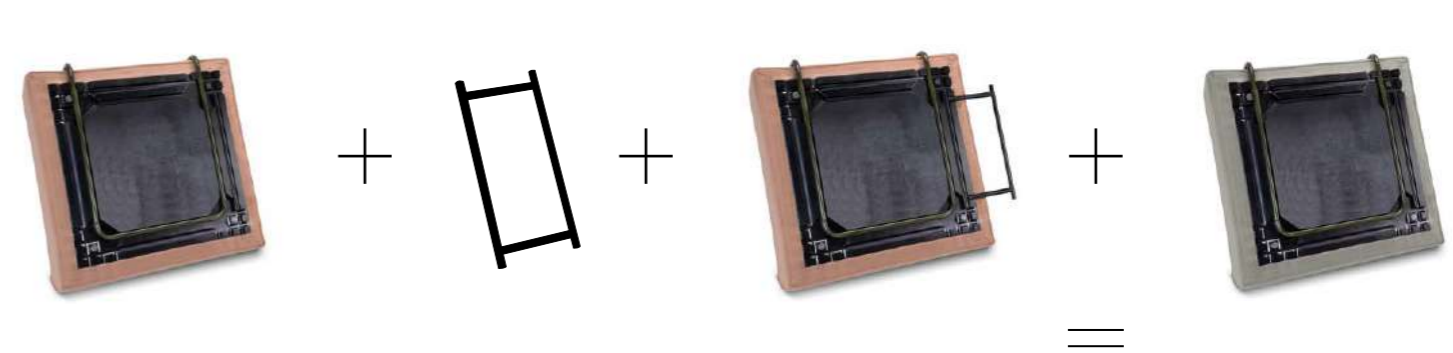

L'elemento di raccordo tiene unite le sedute accostate evitandone lo spostamento durante l'uso. Si innesta ad incastro nelle scanalature in legno della base senza uso di viti. La base è realizzata in legno pantografato, con scanalature per ospitare l'elemento di raccordo e i tubolari dello schienale.

The fastening module holds the seats together side by side, preventing them from shifting during use. It snaps into the wooden grooves on the bottom of the seats; no screws needed. The pantographed wood board bottom of the seat features grooves to accommodate the fastening module and the backrest metal support.



Moduli / Modules

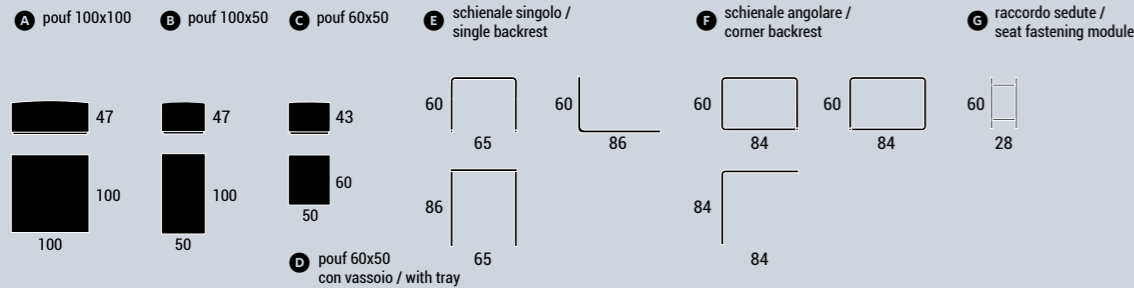

Composizioni suggerite / Suggested configurations

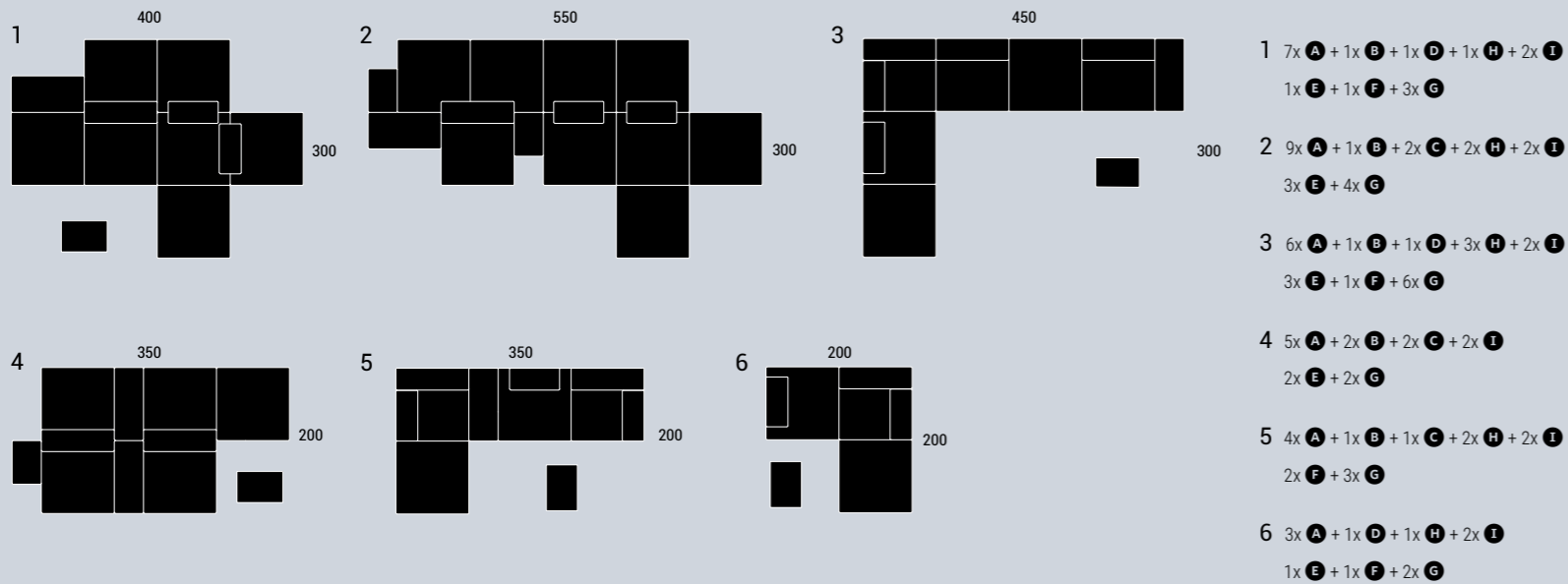

Profondità seduta in base al posizionamento del cuscino schienale
Seating surface varies according to cushion setting

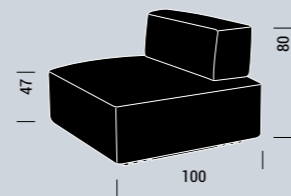

Struttura in legno di abete e multistrato di pioppo in vari spessori, cl. E1 a bassa emissione di formaldeide. Imbottitura in poliuretano espanso indeformabile in densità differenziate da 30 a 40 kg/m³, ovatta in poliestere e piuma sintetica ecocompatibile. Cinghie elastiche da 80 mm. Struttura in legno con scanalature pantografate CNC. Resine e collanti utilizzati sono privi di sostanze ozonolesive, CFC e solventi clorurati. Tutti i materiali impiegati rispettano la normativa EU 91/156 per lo smaltimento dei rifiuti. Prodotto lavorato interamente a mano in Italia.

Fir wood and poplar plywood frame (thickness varies), cl. E1 low formaldehyde emission. Non-deformable polyurethane foam padding (density varies from 30 to 40 kg/m³), polyester wadding and eco-friendly synthetic down. 80-mm elastic straps. Plywood base with CNC pantographed grooves. The resins and adhesives employed are free of ozone-depleting substances, CFCs and chlorinated solvents. All materials used comply with EU 91/156 regulations for waste disposal. Manufactured entirely by hand in Italy.

Crosby



7x A 1x B 1x D 1x H 2x I
1x E 1x F 3x G



9x A 1x B 2x C 2x H 2x I
3x E 4x G



6x A 1x B 1x D 3x H 2x I
3x E 1x F 6x G

Schienali e vassoio Backrests and tray

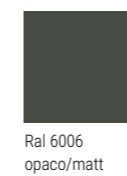

Tessuti Fabrics

Cotone Jacquard Jacquard Cotton

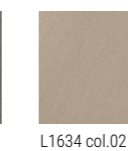
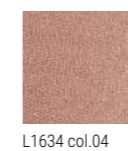

Schienali e vassoio Backrests and tray



Tessuti Fabrics

Pelle Leather

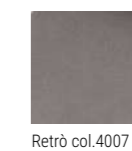

Dettaglio cuciture Stitching detail

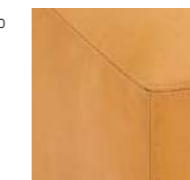

Dettaglio piede Foot detail



Finiture schienali e vassoio pouf 60x50 Backrests and tray for pouf 60x50 finishings

DI SERIE / STANDARD

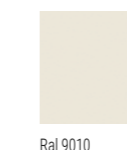
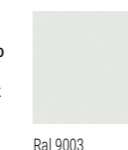

OPTIONAL

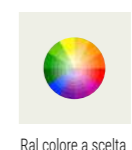

5x A 2x B 2x C 2x I
2x E 2x G



4x A 1x B 1x C 2x H 2x I
2x F 3x G

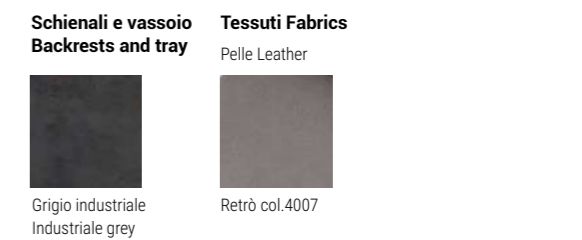

Foy

design **Baldessari e Baldessari**

Disegnare un divano è come raccontare una storia. In questa storia le forme fungono da linee di raccordo tra un pensiero e i materiali che plasmano un nido. Il nido dove ci rifugiamo per farci accogliere e coccolare, per condividere o isolarci. Un nido che, anche quando non utilizzato, deve emanare bellezza. Questo è Foy, il divano degli abbracci.

Designing a sofa is like telling a story. In this story, shapes act as connecting lines between a thought and the materials that make a nest, a cozy welcoming nest which is also a shelter from everything. A corner of the home that radiates beauty. This is Foy, the sofa of hugs.



Divani/Sofas
Foy
Divano tre posti-
poltrona-pouf
Three seater sofa-
armchair-pouf

Tavolino/
Small table
Priamo





Divani/Sofas
Foy
Divano tre posti-
poltrona
Three seater sofa-
armchair
Tavolino/
Small table
Priamo



Divani/Sofas
Foy
 Divano tre posti-
 poltrona
 Three seater sofa-
 armchair

Tavolino/
 Small table
Priamo





Divani/Sofas
Foy
Divano tre posti-
poltrona
Three seater sofa-
armchair

Tavolino/
Small table
Priamo



Divano/Sofa
Foy
Poltrona
Armchair





Divani/Sofas
Foy
Divano due posti-pouf
Two seater sofa-pouf

Tavolini/
Small tables
Taborn



Divano/Sofa
Foy
Divano due posti
Two seater sofa



Divano/Sofa
Foy
Divano tre posti
Three seater sofa



1p /
1s



102

2p /
2s



192

3p /
3s



235

Pouf



45



87

120

Struttura in legno di abete e multistrato di pioppo in vari spessori, cl. E1 a bassa emissione di formaldeide. Imbottitura in poliuretano espanso indeformabile in densità differenziate da 30 a 40 kg/m³, ovatta in poliestere e piuma sintetica ecocompatibile. Cinghie elastiche da 80 mm. Piedi in legno. Resine e collanti utilizzati sono privi di sostanze ozonolesive, CFC e solventi clorurati. Tutti i materiali impiegati rispettano la normativa EU 91/156 per lo smaltimento dei rifiuti. Prodotto lavorato interamente a mano in Italia.

Fir wood and poplar plywood frame (thickness varies), cl. E1 low formaldehyde emission. Non-deformable polyurethane foam padding (density varies from 30 to 40 kg/m³), polyester wadding and eco-friendly synthetic down. 80-mm elastic straps. Wooden legs. The resins and adhesives employed are free of ozone-depleting substances, CFCs and chlorinated solvents. All materials used comply with EU 91/156 regulations for waste disposal. Manufactured entirely by hand in Italy.

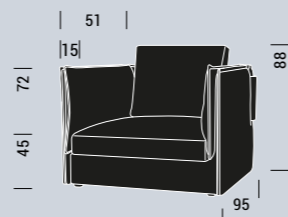

Foy design **Baldessari e Baldessari**



pouf + 3P + 1P
pouf + 3S + 1S



2x 1P + 3P
2x 1S + 3S



2P + pouf
2S + pouf

Tessuti Fabrics

Pelle Nabuk
Nabuk leather

Jaquard

Velluto
Velvet



Retrò col.4018



2124 col.5



Sancho col.24

Pelle Nabuk
Nabuk leather

Jaquard

Velluto
Velvet



Retrò col.4018



2124 col.5



Sancho col.24

Velluto
Velvet

Velluto di lino
Linen velvet

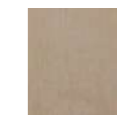

Sancho col.30



G077 col.18

Pelle Leather

Jaquard riciclato
Recycled jaquard



Moon col.651



Raytent 3706 col.708

**Dettaglio piede
Foot detail**



P 59
H 2

Piede in legno
tinto nero
Black stained
wooden foot

Tilton

Tilton è la collezione degli incastri perfetti. Un Tetris contemporaneo costruito con soli tre elementi essenziali che si lasciano combinare all'infinito, mentre il gioco di equilibri tra geometrie e morbidezze cattura lo sguardo, soddisfacendo l'occhio attento ai dettagli.

Tilton is a series of square combinations, a contemporary Tetris built out of three essential modules that can be endlessly combined. The balanced interplay between geometry and softness catches the eye, harmonizing rigor and ease.



Divani/Sofas
Tilton
Composizione 1
Composition 1

Poltrona/
Armchair
Dizzy

Pouf/Poufs
Billie

Tavolini/
Small tables
Taborn



Divani/Sofas
Tilton
Composizione 1
Composition 1

Pouf/Poufs
Billie

Tavolini/
Small tables
Taborn

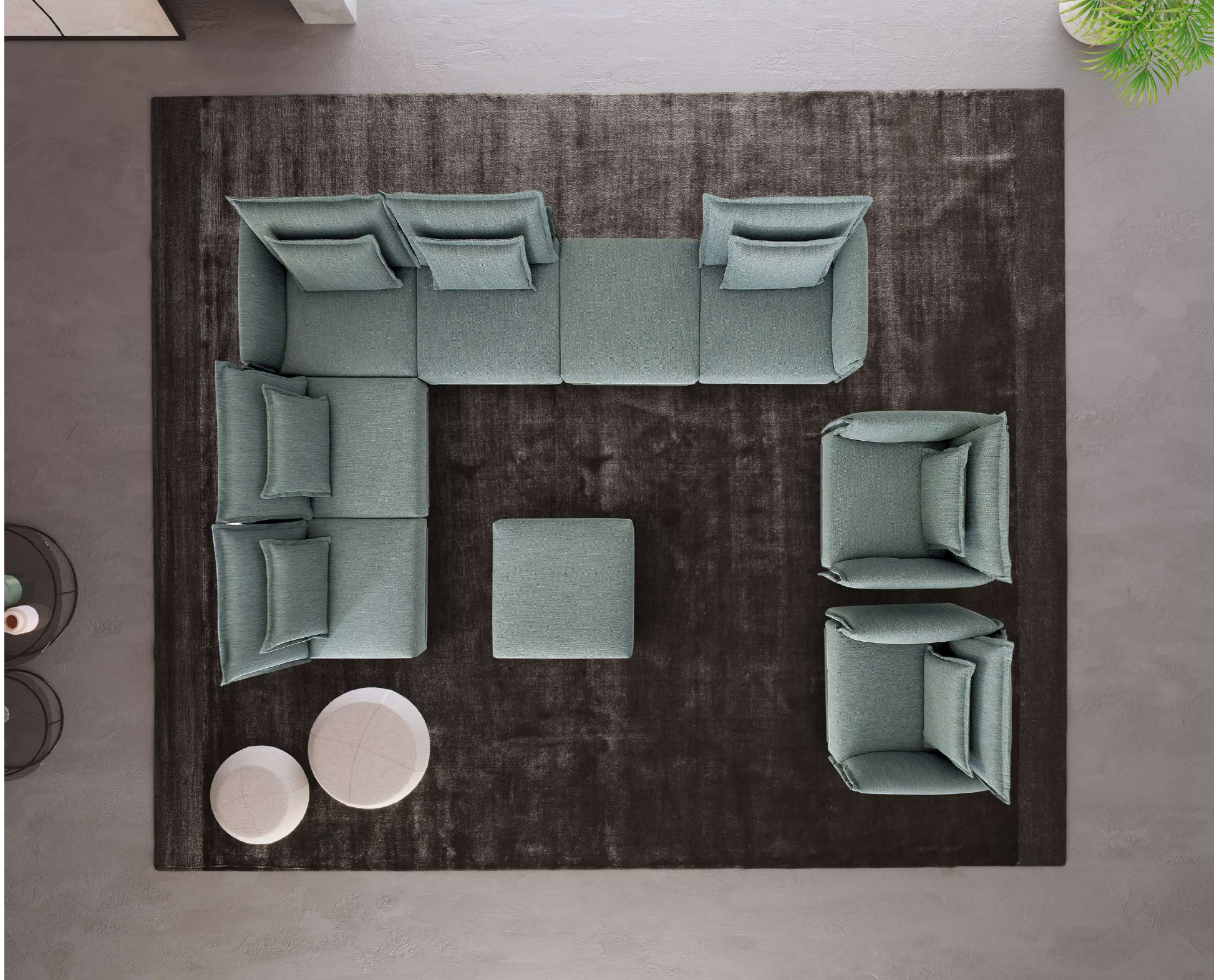



Quando i dettagli seguono il ritmo delle forme in modo piacevole e fluido, e le morbidezze si susseguono con armonia alle rigidità, tutto quello che resta da fare è lasciarsi trasportare dalla bellezza, nella bellezza.

When details follow the rhythm of shapes nicely and smoothly, and softness harmoniously alternates with stiffness, you may just let beauty carry you away.



Divani/Sofas
Tilton
Composizione 1
Composition 1

Poufs
Billie

Tavolini/
Small tables
Taborn

Divano/Sofa
Tilton
Poltrona
Armchair



Divani/Sofas
Tilton
Composizione 2
Composition 2

Tavolini/
Small tables
Zaikin

Modularità/Modularity



Flessibilità/Flexibility



Poltrona laterale dx/sx Armchair right/left armrest



Poltrona Armchair



Pochi elementi per costruire una poltrona o un grande divano. Un pouf, una lamiera che funge da schienale o bracciolo, tre cuscini e tanta modularità. Il divano Tilton si presta a diverse configurazioni con la libertà di cambiare idea e gestirlo con semplicità.

The same few modules can make up an armchair or a large sofa: an ottoman, a metal sheet that can be a backrest- or an armrest, three cushions and lots of modularity. The Tilton sofa lends itself to different configurations and leaves you the freedom to change your mind - simple and easy.

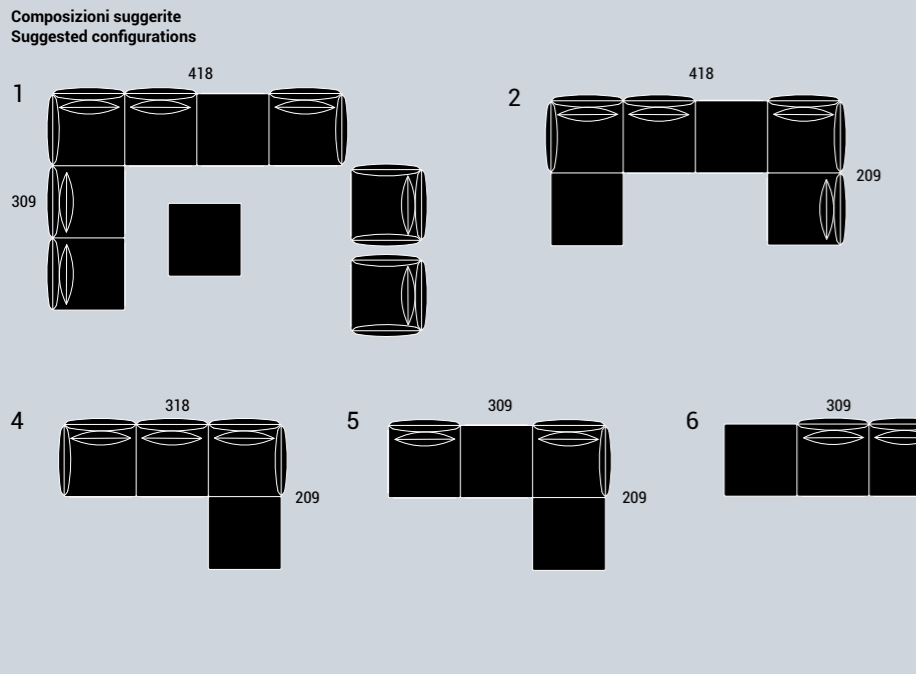
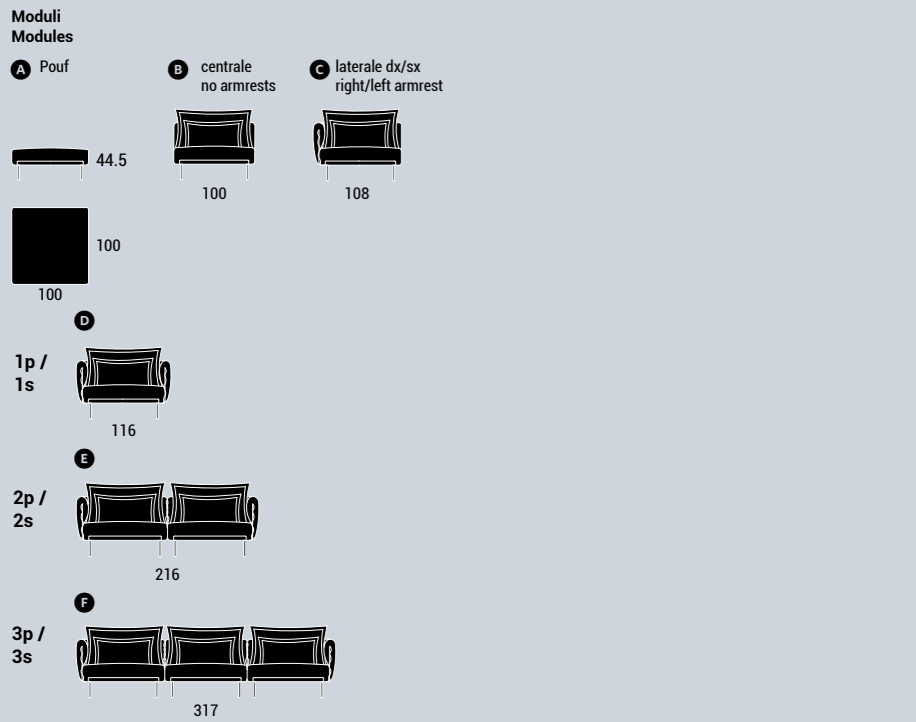

Struttura in legno di abete e multistrato di pioppo in vari spessori, cl. E1 a bassa emissione di formaldeide. Imbottitura in poliuretano espanso indeformabile in densità differenziate da 30 a 40 kg/m³, ovatta in poliestere e piuma sintetica ecocompatibile. Struttura e piedi in metallo. Resine e collanti utilizzati sono privi di sostanze ozonolesive, CFC e solventi clorurati. Tutti i materiali impiegati rispettano la normativa EU 91/156 per lo smaltimento dei rifiuti. Prodotto lavorato interamente a mano in Italia.

Fir wood and poplar plywood frame (thickness varies), cl. E1 low formaldehyde emission. Non-deformable polyurethane foam padding (density varies from 30 to 40 kg/m³), polyester wadding and eco-friendly synthetic down. Metal frame and legs. The resins and adhesives employed are free of ozone-depleting substances, CFCs and chlorinated solvents. All materials used comply with EU 91/156 regulations for waste disposal. Manufactured entirely by hand in Italy.

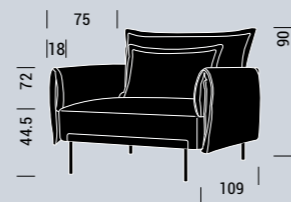

2x **A** 3x **B** 1x **C** sx/left
1x **C** dx/right 2x **D**

Piedi Feet



Grigio industriale Industrial grey

Tessuti Fabrics



G192 col.19



2x **A** 2x **B**
1x **C** sx/left 1x **C** dx/right

Piedi Feet



Ral 9016 lucido polished

Tessuti Fabrics



04250 Levante col.315

Dettaglio piede Foot detail



P 108 H 20
Piede in metallo verniciato Varnished metal frame

Dettaglio lamiera Metal sheet detail



H 5
Elemento decorativo in metallo verniciato Painted metal decorative element

Dettaglio cuscini Detail of the cushions



Finiture lamiera e piede metallo Metal sheet and foot finishings

DI SERIE / STANDARD

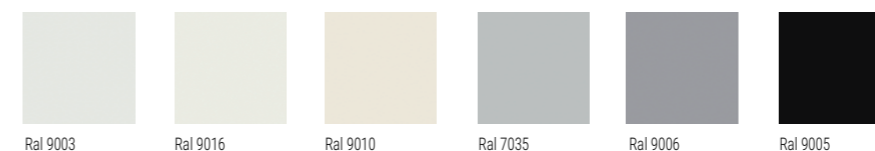

OPTIONAL



Tilton



Poltrone e pouf

Armchairs and poufs

I complementi sono note virtuose che si
espandono nell'ambiente perfezionandolo.

Accessories are virtuoso
details that define
any setting and hone
it to perfection.

109



Finiture fascia laminato
Laminated ring finishings

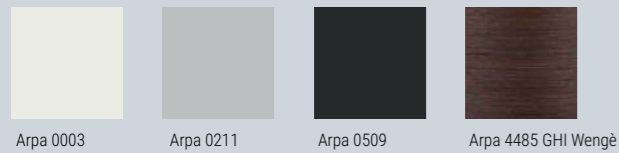

Struttura in legno di abete e multistrato di pioppo in vari spessori, cl. E1 a bassa emissione di formaldeide. Imbottitura in poliuretano espanso indeformabile in densità differenziate da 30 a 40 kg/m³, ovatta in poliester e piuma sintetica ecocompatibile. Elemento decorativo il laminato.

Dinah

Fir wood and poplar plywood frame (thickness varies), cl. E1 low formaldehyde emission. Non-deformable polyurethane foam padding (densities vary from 30 to 40 kg/m³), polyester wadding and eco-friendly synthetic down. Decorative laminate element.

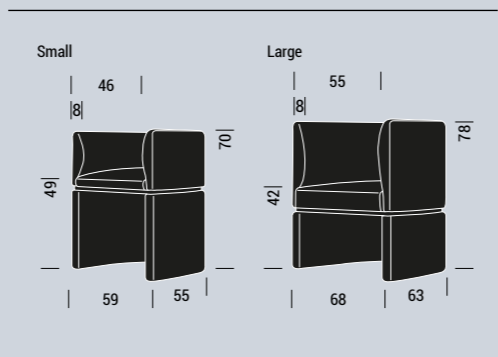

Finiture base metallo
Metal base finishings

DI SERIE / STANDARD

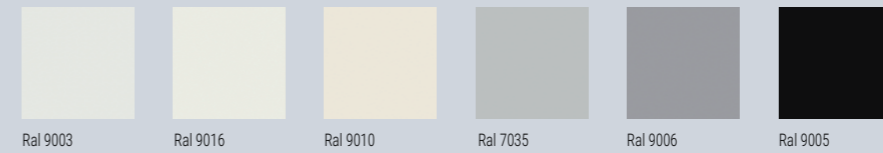

OPTIONAL

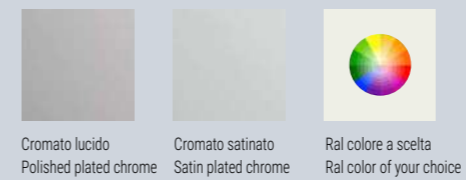

Struttura in legno di abete e multistrato di pioppo in vari spessori, cl. E1 a bassa emissione di formaldeide. Imbottitura in poliuretano espanso indeformabile in densità differenziate da 30 a 40 kg/m³, ovatta in poliester e piuma sintetica ecocompatibile. Base girevole in metallo.

Parker

Fir wood and poplar plywood frame (thickness varies), cl. E1 low formaldehyde emission. Non-deformable polyurethane foam padding (densities vary from 30 to 40 kg/m³), polyester wadding and eco-friendly synthetic down. Metal swivel base.

Dettaglio piede
Foot detail

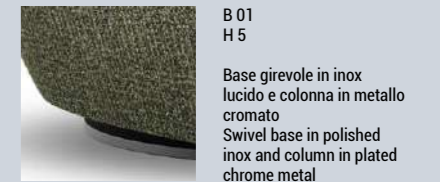

B 01
H 5
Base girevole in inox lucido e colonna in metallo cromato
Swivel base in polished inox and column in plated chrome metal

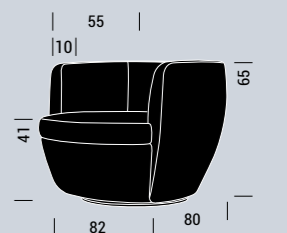



Zoccolo laminato
Laminate plinth

DI SERIE / STANDARD

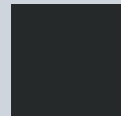

Arpa 0509

OPTIONAL

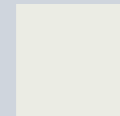

Arpa 0003



Arpa 0211

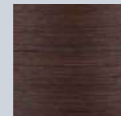

Arpa 4485 GHI Wengè

OPTIONAL



Arpa 2006 LUC
Ottone lucido
Polished brass



Arpa 2003 SAT
Alluminio dorato
satinato Satin
golden aluminium



Arpa 2000 SAT
Alluminio satinato
Satin aluminium

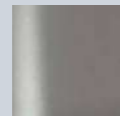

Arpa 2007 CT
Canna di fucile cotton
Cotton gunmetal

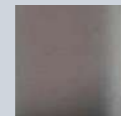

Arpa 2012 SAT
ALU STEEL
satinato satin



Arpa 2008 SAT
Rame CA satinato
Satin copper CA

Tessuti
Fabrics

Velluto Velvet

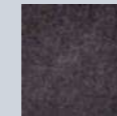

Barkley col.30

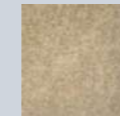

Barkley col.06

Dettaglio piede
Foot detail



B 12

H 5

Zoccolo in laminato
Arpa 0509
Laminated wooden
plinth Arpa 0509

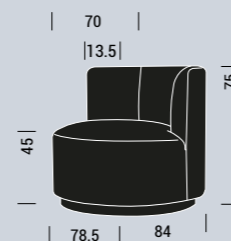

Struttura in legno di abete e multistrato di pioppo in vari spessori, cl. E1 a bassa emissione di formaldeide. Imbottitura in poliuretano espanso indeformabile in densità differenziate da 30 a 40 kg/m³, ovatta in poliestere e piuma sintetica ecocompatibile. Zoccolo in legno rivestito in laminato.

Fir wood and poplar plywood frame (thickness varies), cl. E1 low formaldehyde emission. Non-deformable polyurethane foam padding (densities vary from 30 to 40 kg/m³), polyester wadding and eco-friendly synthetic down. Wooden plinth clad with laminate.

Duke



Finiture piedi metallo
Metal feet finishings

DI SERIE / STANDARD

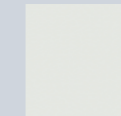

Ral 9003



Ral 9016



Ral 9010

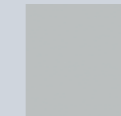

Ral 7035

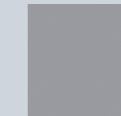

Ral 9006

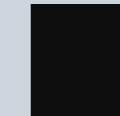

Ral 9005

OPTIONAL

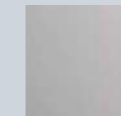

Cromato lucido
Polished plated chrome



Cromato satinato
Satin plated chrome



Ral colore a scelta
Ral color of your choice

Tessuti
Fabrics

Velluto Velvet



Barkley col.27

Pelle Leather

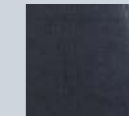

Lux col.2438

Velluto Velvet



Barkley col.15

Pelle Leather

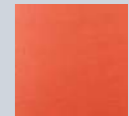

Lux col.2408

Dettaglio piede
Foot detail



P 113

H 22/18

Piedi in metallo verniciato
Varnished metal feet

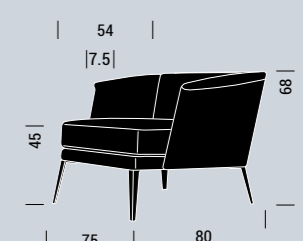

Struttura in legno di abete e multistrato di pioppo in vari spessori, cl. E1 a bassa emissione di formaldeide. Imbottitura in poliuretano espanso indeformabile in densità differenziate da 30 a 40 kg/m³, ovatta in poliestere e piuma sintetica ecocompatibile. Piedi in metallo.

Fir wood and poplar plywood frame (thickness varies), cl. E1 low formaldehyde emission. Non-deformable polyurethane foam padding (densities vary from 30 to 40 kg/m³), polyester wadding and eco-friendly synthetic down. Metal feet.

Dizzy

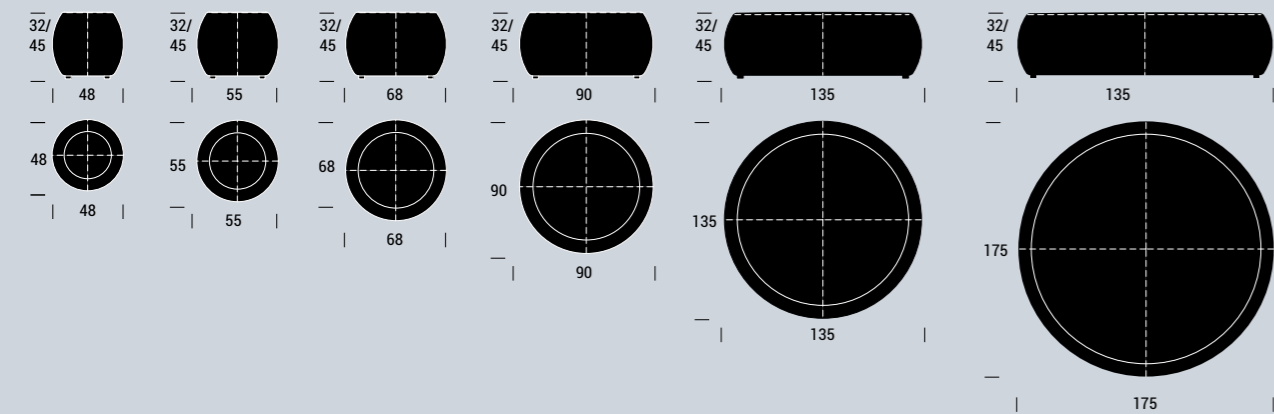

Struttura in legno di abete e multistrato di pioppo in vari spessori, cl. E1 a bassa emissione di formaldeide. Imbottitura in poliuretano espanso indeformabile in densità differenziate da 30 a 40 kg/m³, ovatta in poliestere e piuma sintetica ecocompatibile. Piedi a scomparsa.

Billie

Fir wood and poplar plywood frame (thickness varies), cl. E1 low formaldehyde emission. Non-deformable polyurethane foam padding (densities vary from 30 to 40 kg/m³), polyester wadding and eco-friendly synthetic down. Retractable feet.

Tessuti Fabrics

Velluto Velvet

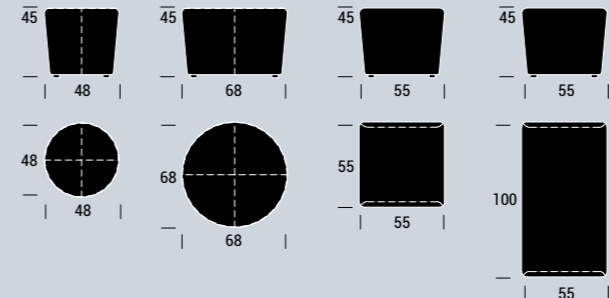
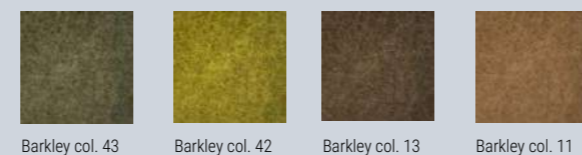

Struttura in legno di abete e multistrato di pioppo in vari spessori, cl. E1 a bassa emissione di formaldeide. Imbottitura in poliuretano espanso indeformabile in densità differenziate da 30 a 40 kg/m³, ovatta in poliestere e piuma sintetica ecocompatibile. Piedi a scomparsa.

Frank

Fir wood and poplar plywood frame (thickness varies), cl. E1 low formaldehyde emission. Non-deformable polyurethane foam padding (densities vary from 30 to 40 kg/m³), polyester wadding and eco-friendly synthetic down. Retractable feet.

Tessuti Fabrics

Velluto Velvet

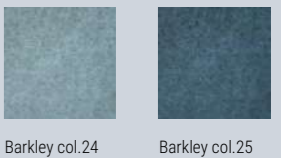



**Tessuti
Fabrics**

Velluto Velvet



Barkley col.44

Barkley col.45

Struttura in legno di abete e multistrato di pioppo in vari spessori, cl. E1 a bassa emissione di formaldeide. Imbottitura in poliuretano espanso indeformabile in densità differenziate da 30 a 40 kg/m³, ovatta in poliestere e piuma sintetica ecocompatibile. Piedi a scomparsa.

Joe

Fir wood and poplar plywood frame (thickness varies), cl. E1 low formaldehyde emission. Non-deformable polyurethane foam padding (densities vary from 30 to 40 kg/m³), polyester wadding and eco-friendly synthetic down. Retractable feet.

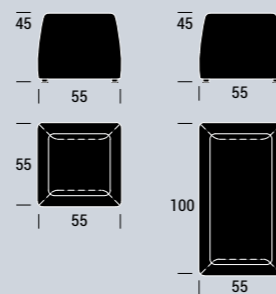



Tavolini

Small tables

L'originalità di un accessorio sta nel qui e ora, come un assolo improvvisato e inaspettato, di cui non si potrà più fare a meno.

The originality of an accessory lies in its hic et nunc. It is an impromptu and unexpected solo that you will never be able to do without.

119

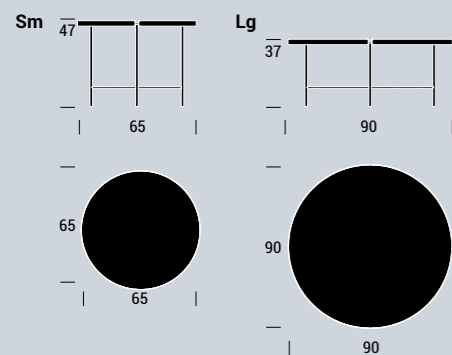

Struttura in metallo verniciato in colori di serie o optional oppure in finitura galvanica; piano in legno o vetro laccato.

Metal frame painted with standard or optional colors or galvanized finish; wooden or laquered top.

Tabbal design Luca Roccadadria

Finiture struttura e cornice piano
Legs and top frame finishings

DI SERIE / STANDARD

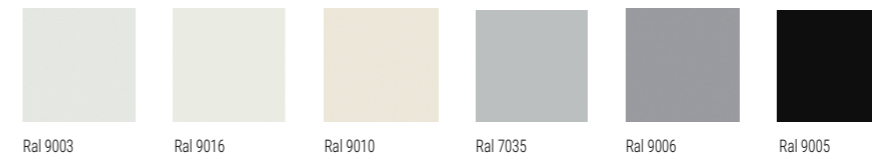

OPTIONAL



Finiture piano legno
Wooden top finishings

DI SERIE / STANDARD

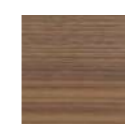

Noce Canaletto
Canaletto walnut

OPTIONAL

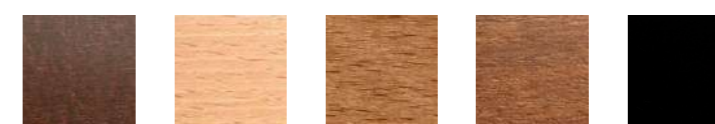

10 Wengè
01 Naturale Natural
04 Noce chiaro
Light walnut
05 Noce Walnut
07/20 Nero Black

Finiture piano vetro laccato
Laquered glass top finishings

DI SERIE / STANDARD



Ral colore a scelta
Ral color of your choice

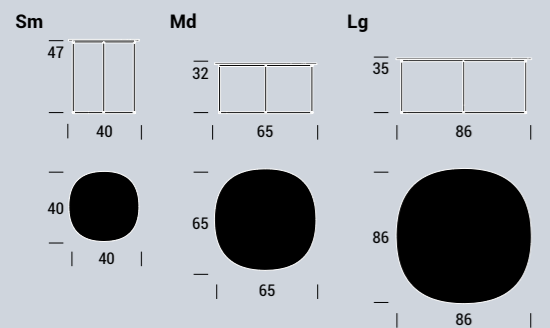

Struttura in metallo verniciato in colori di serie o optional oppure in finitura galvanica; piano in vetro laccato o ricotto.

Metal frame painted with standard or optional colors or galvanized finish; annealed glass or laquered glass top.

Taborn design Luca Roccadadria

Finiture struttura metallo
Metal frame finishings

DI SERIE / STANDARD

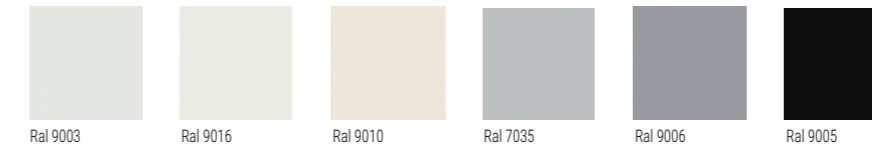

OPTIONAL



Finiture piano vetro ricotto
Annealed glass top finishings

DI SERIE / STANDARD

Trasparente / Transparent



OPTIONAL

Coprente/Full colour



Finiture piano vetro laccato
Laquered glass top finishings

DI SERIE / STANDARD



Vetro laccato
Ral colore a scelta
Laquered glass Ral
color of your choice

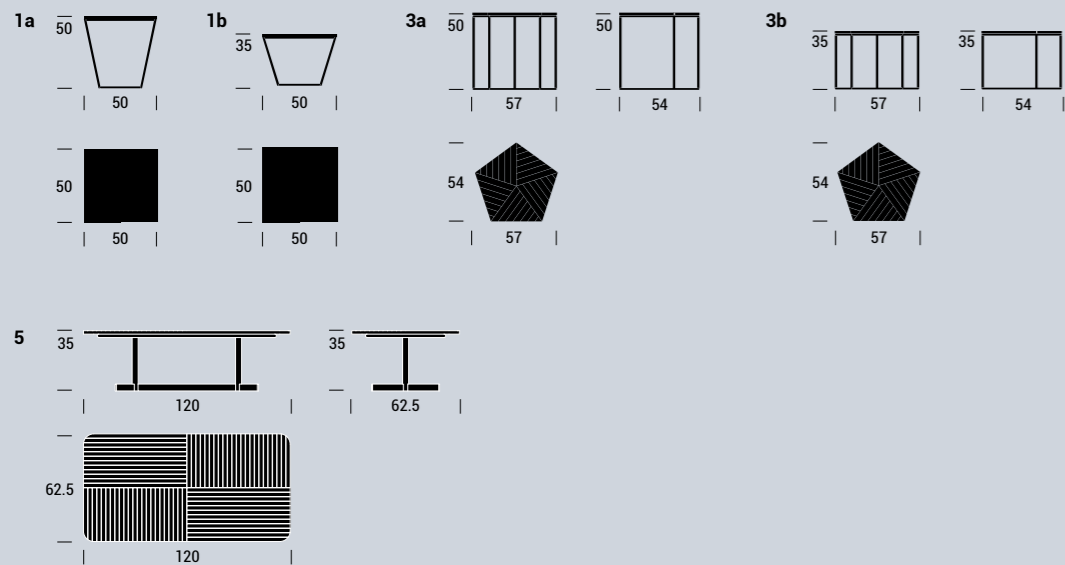

Struttura in metallo verniciato in colori di serie o optional oppure in finitura galvanica, piano in cemento stampato con scanalature riempite con innesto di vernice colorata o in marmo.

Metal frame painted with standard or optional colors or galvanized finish; stamped concrete top with grooves filled with colored paint graft or marble top.

Priamo

design **Roberto Giacomucci**

Finiture struttura metallo Metal frame finishings

DI SERIE / STANDARD

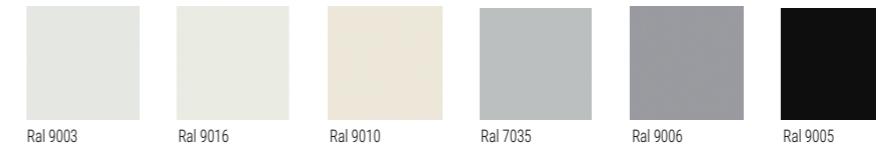

OPTIONAL



Finitura piano in cemento Concrete top finishing

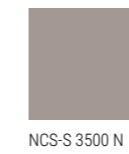

Colori fughe Joints colors



Finiture piano marmo Marble top finishings

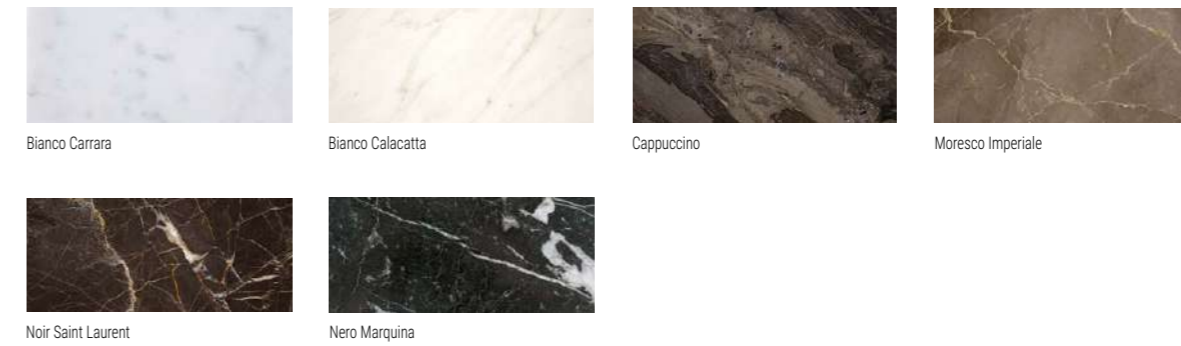

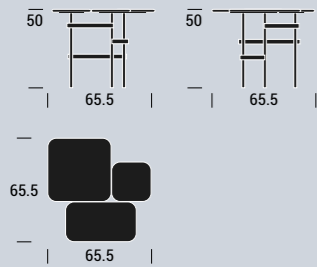

Struttura in metallo verniciato in colori di serie o optional oppure in finitura galvanica; piano in cemento stampato o in marmo.

Metal frame painted with standard or optional colors or galvanized finish; stamped concrete top or marble top.

Tablette

design Roberto Giacomucci

Finiture struttura metallo Metal frame finishings

DI SERIE / STANDARD

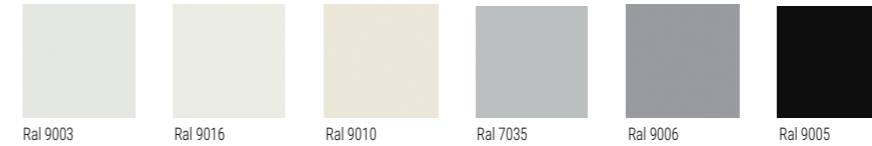

OPTIONAL



Finiture piano cemento Concrete top finishing



Ral colore a scelta
Ral color of your choice

Finiture piano marmo Marble top finishings

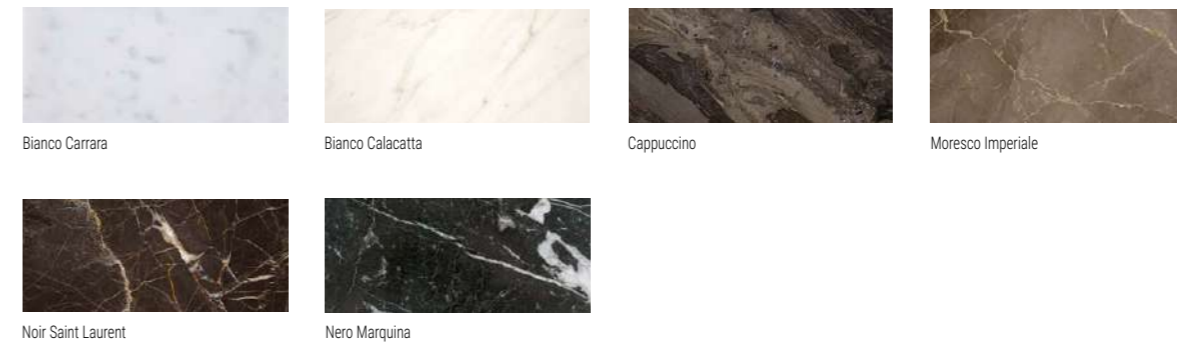



Piano in vetro
glass top

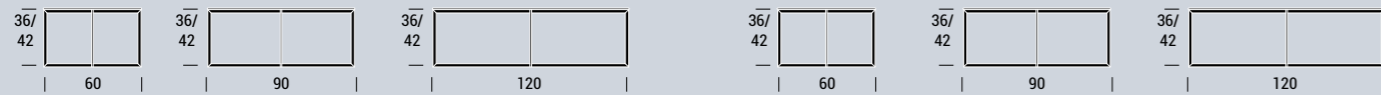

Piano in marmo
marble top

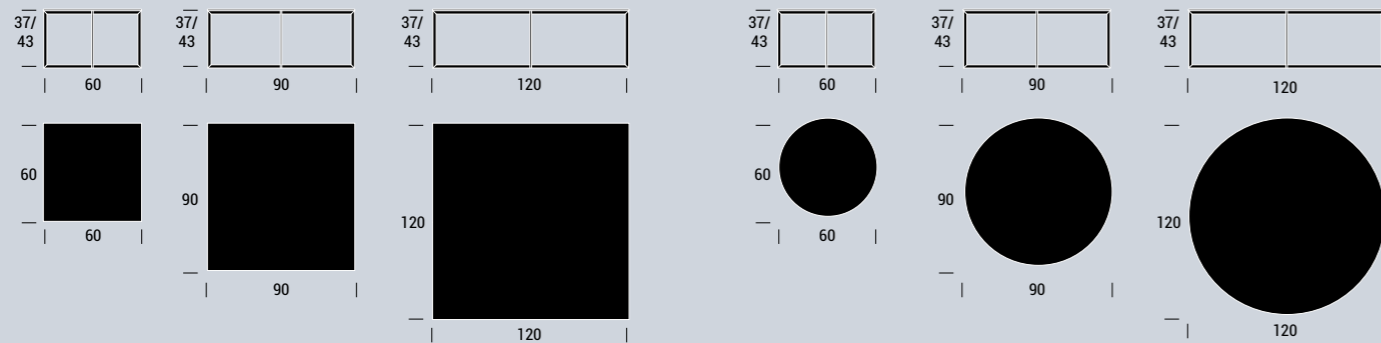

Struttura in metallo verniciato in colori di serie o optional oppure in finitura galvanica, piano in vetro o marmo.

Metal frame painted with standard or optional colors or galvanized finish; glass or marble top.

Warhol

Finiture struttura metallo
Metal frame finishings

DI SERIE / STANDARD



Ral 9016



Ral 9011



Cromato lucido
Polished plated chrome

OPTIONAL

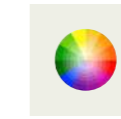

Ral colore a scelta
Ral color of your choice

Finiture piano vetro
Glass top finishings

DI SERIE / STANDARD



Vetro trasparente
Transparent glass

OPTIONAL



Vetro laccato
Ral colore a scelta
Laquered glass Ral
color of your choice

Finiture piano marmo
Marble top finishings



Bianco Carrara

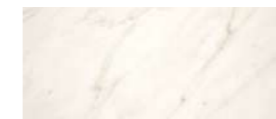

Bianco Calacatta



Cappuccino

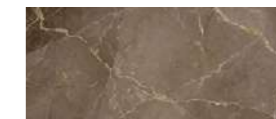

Moresco Imperiale



Noir Saint Laurent



Nero Marquina

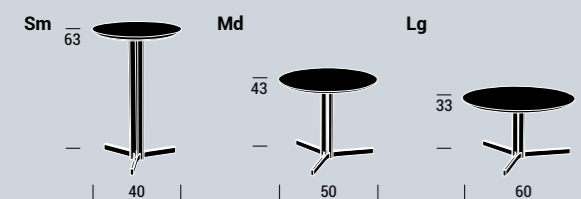

Struttura in metallo.
 Finiture: versione ottone brunito verniciata a polveri, versioni ottone lucido e canna di fucile trattate con finitura galvanica e protezione trasparente. Piano in marmo naturale protetto con antimacchia, spessore 2 cm.

Metal frame.
 Finishes: the burnished brass version features a powder-coated finish; the polished brass and gunmetal versions feature a galvanised finish with transparent protection. Stain-resistant, 2 cm-thick natural marble top.

Ceo

Finiture struttura metallo Metal frame finishings

DI SERIE / STANDARD

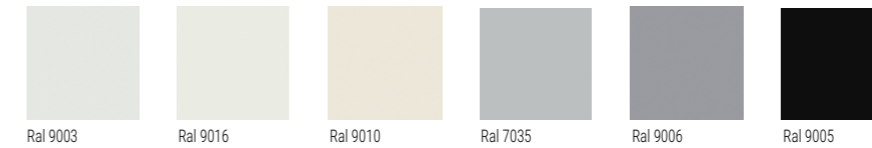

OPTIONAL



Finiture piano marmo Marble top finishings

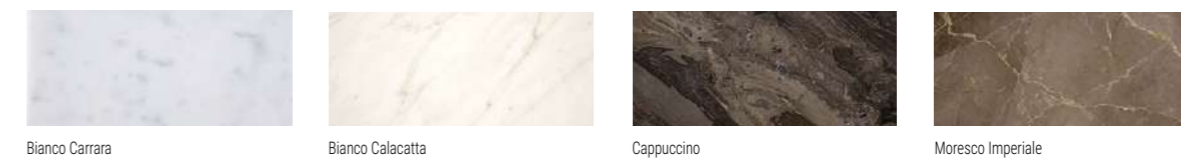



Tavoli/Tables

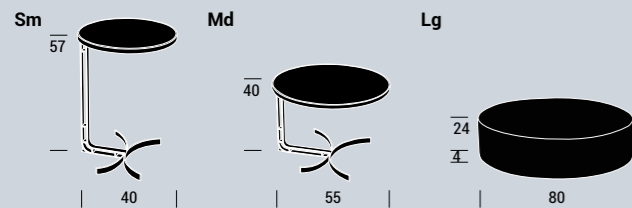

Pouf

**Tessuti
Fabrics**

Velluto Velvet

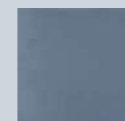

8336 col.55

Struttura in metallo.
Finiture: versione ottone brunito verniciata a polveri, versioni ottone lucido e canna di fucile trattate con finitura galvanica e protezione trasparente.
Piano in ceramica effetto marmo, spessore 6 mm ottenuto tramite cottura, spazzolatura e lucidatura meccanica. Superficie lucida, riflettente e antimacchia.

Metal frame.
Finishes: the burnished brass version features a powder-coated finish; the polished brass and gunmetal versions feature a galvanised finish with transparent protection.
6 mm-thick ceramic top with marble finish obtained by firing, brushing and mechanical polishing. Polished, reflective and stain-resistant surface.

Febe

**Finiture struttura metallo
Metal frame finishings**

DI SERIE / STANDARD

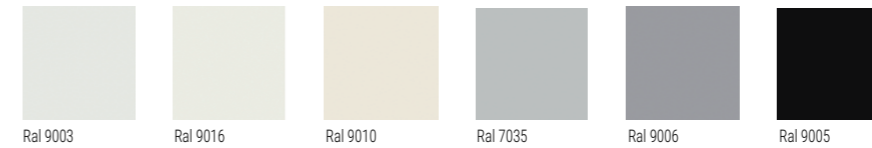

OPTIONAL

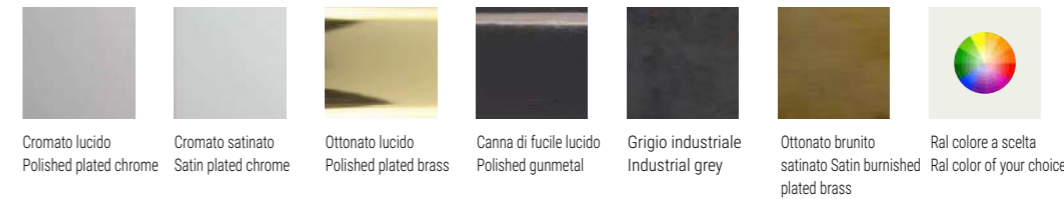

**Finiture piano marmo
Marble top finishings**

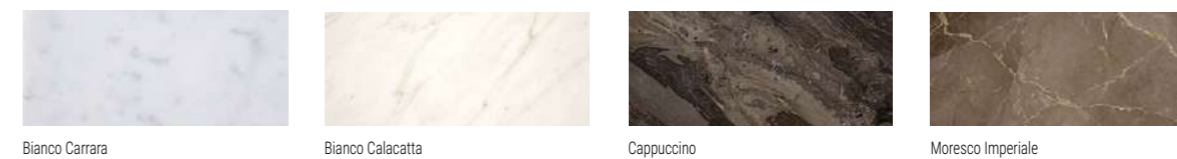

**Finiture piano ceramica
Ceramic top finishings**

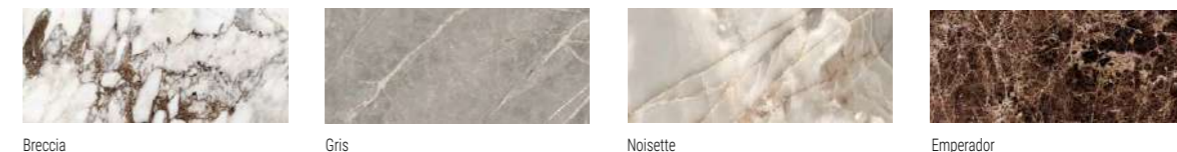

**Dettaglio piede pouf
Foot pouf detail**



POUF
P 59
H 4

Zoccolo multistrato
laminato nero
Plinth in black laminated
plywood

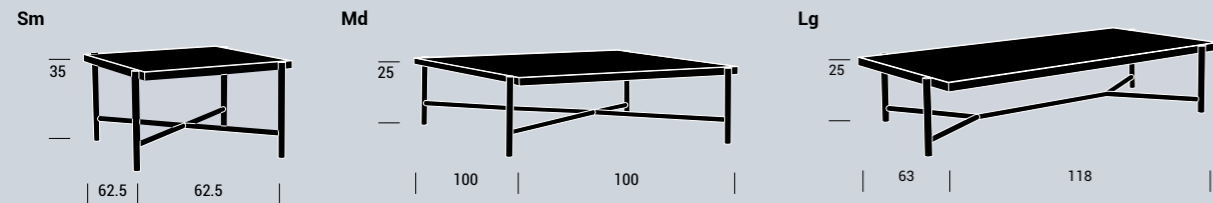

Struttura in metallo.
 Finiture: versione ottone brunito verniciata a polveri, versioni ottone lucido e canna di fucile trattate con finitura galvanica e protezione trasparente. Piano in ceramica effetto marmo, spessore 6 mm ottenuto tramite cottura, spazzolatura e lucidatura meccanica. Superficie lucida, riflettente e antimacchia.

Metal frame.
 Finishes: the burnished brass version features a powder-coated finish; the polished brass and gunmetal versions feature a galvanised finish with transparent protection. 6 mm-thick ceramic top with marble finish obtained by firing, brushing and mechanical polishing. Polished, reflective and stain-resistant surface.

Rea

Finiture struttura metallo
Metal frame finishings

DI SERIE / STANDARD

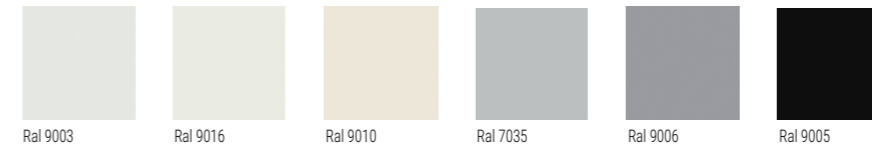

OPTIONAL



Finiture piano marmo
Marble top finishings

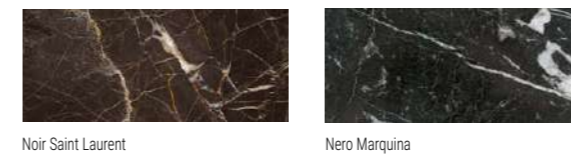
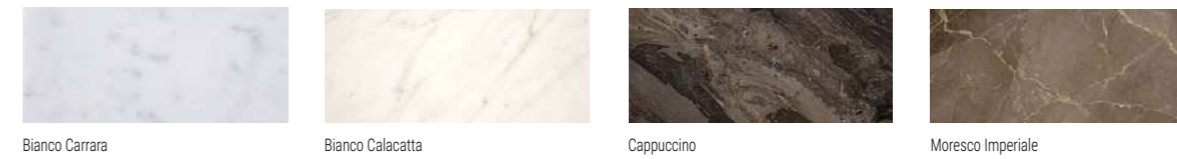

Finiture piano ceramica
Ceramic top finishings

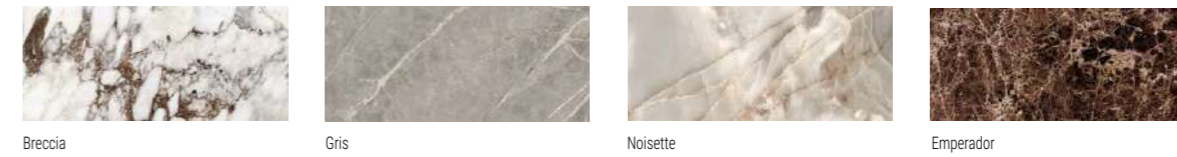

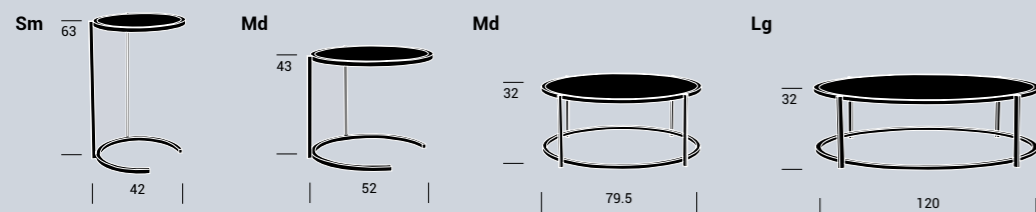

Struttura in metallo.
 Finiture: versione ottone brunito verniciata a polveri, versioni ottone lucido e canna di fucile trattate con finitura galvanica e protezione trasparente. Piano in ceramica effetto marmo, spessore 6 mm ottenuto tramite cottura, spazzolatura e lucidatura meccanica. Superficie lucida, riflettente e antimacchia.

Teti

Metal frame.
 Finishes: the burnished brass version features a powder-coated finish; the polished brass and gunmetal versions feature a galvanised finish with transparent protection. 6 mm-thick ceramic top with marble finish obtained by firing, brushing and mechanical polishing. Polished, reflective and stain-resistant surface.

Finiture struttura metallo Metal frame finishings

DI SERIE / STANDARD

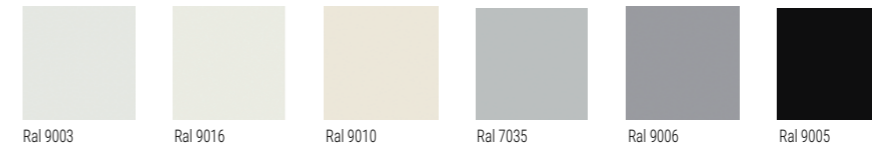

OPTIONAL

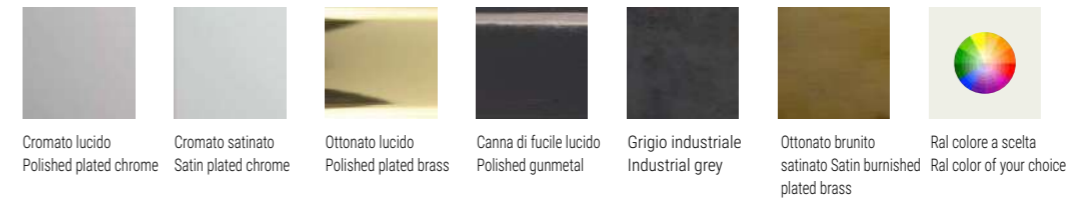

Finiture piano marmo Marble top finishings

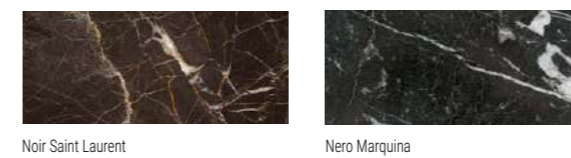
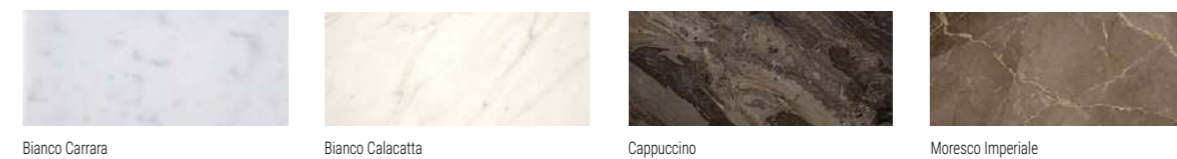

Finiture piano ceramica Ceramic top finishings

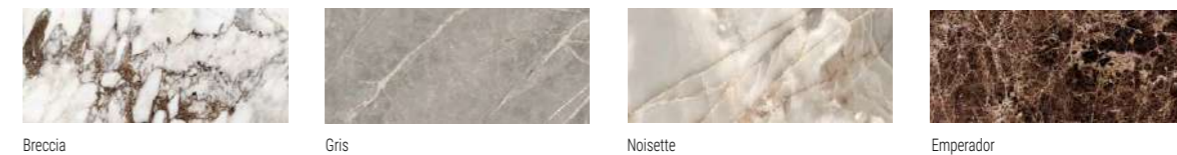

Sahara noir



Finitura struttura metallo
Metal frame finishing



Ral 9005

Finitura piano vetro
Glass top finishing



Vetro temperato verniciato
nero lucido coprente
Tempered varnished polished
black glass top

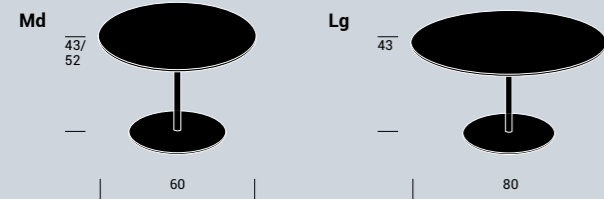

Struttura in metallo, piano in vetro verniciato
nero.

Metal frame; black painted glass top.

Zaikin

DOMINGO®

Strada della Romagna, 285
61121 PESARO (ITALY)
T +39 0721 208080
info@domingo.it
www.domingo.it

Coordinamento generale Project management	Valentina Bigiarini & Francesca Grassi
Grafica Graphic design	ma:design Pesaro
Foto Photo	Mauro Foli Cervia
Testi Texts	Valentina Bigiarini
Render	EIDO Roccadadria INDUSTRIAL DESIGN Simone Roscini Cattolica
Fotolito Litograph	Lifeinpixel Pesaro
Stampa Print	Gruppo Leardini Fano
Edizione 1 Issue 1	Marzo 2023 March 2023

Diritti riservati. La riproduzione anche parziale è consentita solo previa autorizzazione scritta di Domingo Salotti s.r.l.
All rights reserved. No parts of this catalogue may be reproduced without permission in writing from Domingo Salotti s.r.l.

Contemporary living

domingo.it